



HORIZONTAL POUCH MACHINES

**GPC-60**

## CARACTERÍSTICAS EFFYTEC

- Carga frontal de bobinas
- Máquina de reducidas dimensiones y de mayor producción
- Bancada autoportante, limpia y sin concavidades
- Ejecución inox estándar
- Ejes de bobina expandibles sin necesidad de herramientas
- Carrusel continuo
- Levas de baja inercia
- Sistema de corte de alta resistencia y bajo mantenimiento
- Configuración eléctrica en red
- Tele asistencia remota
- Desbobinado continuo
- Memorias de formato programadas en recetas

## EFFYTEC FEATURES

- Front reels loading
- Machine with reduced sizes and higher output
- Self-supported frame, clean and without holes
- Standard stainless execution
- Reel shafts expandable without toolings
- Continuous carousel
- Low inertia cams
- Low maintenance and high durability cutting device
- Net electrical configuration
- Remote tele assistance
- Continuous unwinding
- Formats memory programmed in recipes

## CARACTERISTIQUES EFFYTEC

- Chargement frontale de bobines
- Machine de mesures réduites et plus haute performance
- Bâti autosupportable, propre et sans concavités
- Exécution inoxydable standard
- Axes de bobine extensibles sans besoin d'outillages
- Carrousel continu
- Cames de baisse inertie
- Système de coupage d'haute résistance et baisse maintenance
- Configuration électrique en réseau
- Télé assistance à distance
- Déroulage continu
- Mémoires de formats programmées en recettes

## MACHINE DIMENSIONS

	A	B	C	D*	E*
GPC-60	7728	1810	1862	4900	10100
GPC-60 ZIPPER	8528	1810	1862	4900	10900

\*minimum recommendable location area. Dimensions = mm.

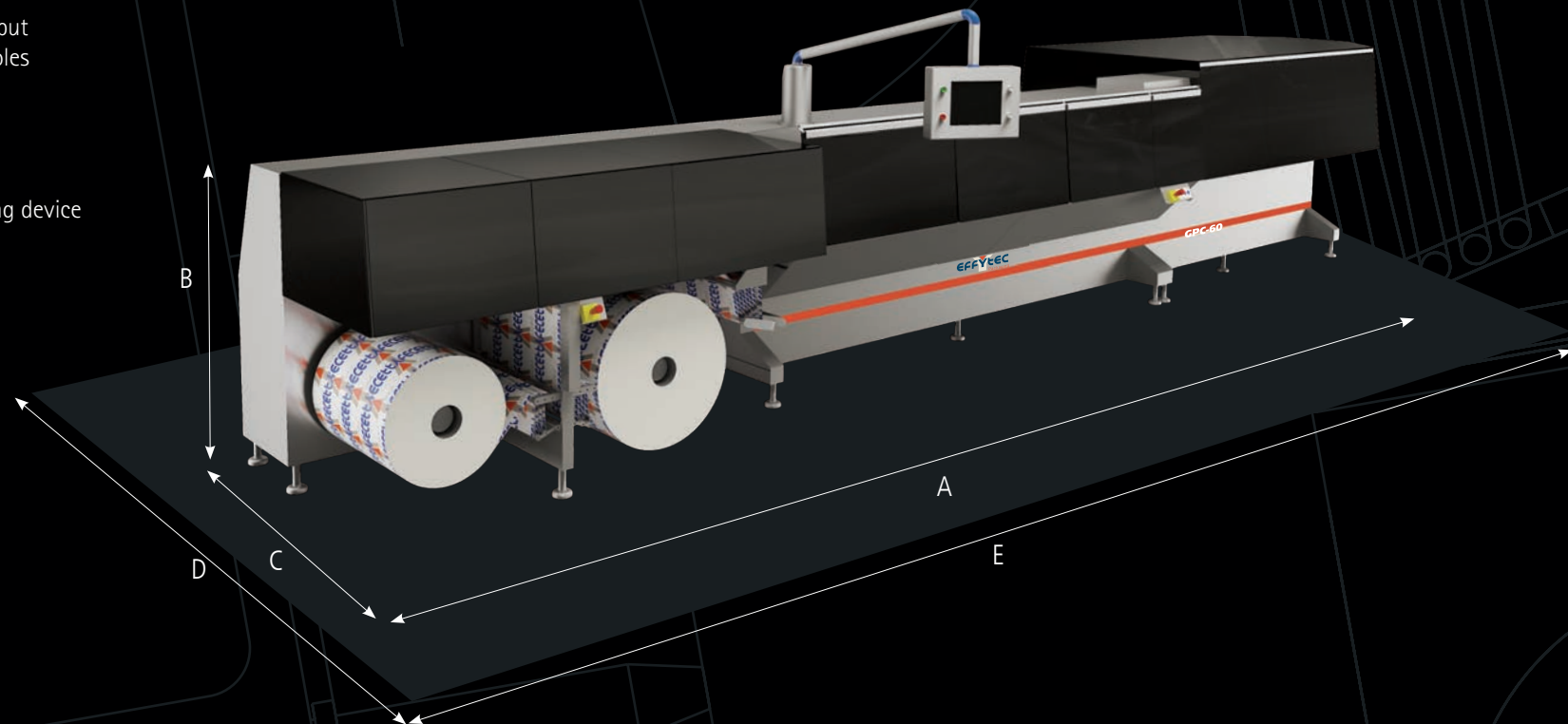

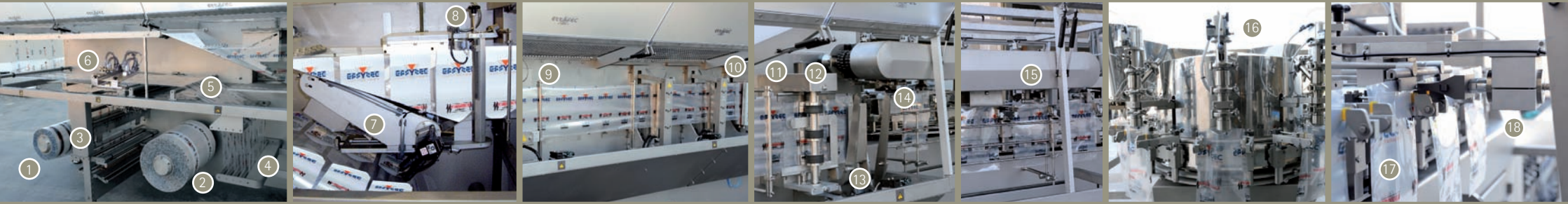

- 1 Eje bobina expandible de fijación neumática
- 2 Segundo eje de bobina
- 3 Empalmador automático de bobina
- 4 1er grupo de rodillos compensadores
- 5 Rodillos desbobinado
- 6 Grupo perforador de fondo de fácil ajuste
- 7 Triángulo formador (nuevo formato sólo cambio puntera)
- 8 Alineador automático film
- 9 Grupos soldadura (4 mordazas motorizadas)
- 10 Enfriador
- 11 Fococélula fija
- 12 Arrastré film por rodillos servo
- 13 Grupo tijeras de fácil desmontaje para mantenimiento
- 14 Pinza transferencia a carrusel
- 15 Estación abertura
- 16 Estación de llenado (3)
- 17 Estirado independiente de la boca del sobre
- 18 Soldadura superior por Ultrasonidos

- 1 Expandible reel axe of pneumatic fixation
- 2 Second reel axe
- 3 Automatic film splicer
- 4 1st group of compensating rollers
- 5 Unwinding pulling rollers
- 6 Bottom perforating punch of easy adjustment
- 7 Forming plough (only changing triangle edge for further formats)
- 8 Automatic film alignment
- 9 Sealing groups (4 motorized sealing)
- 10 Cooling plate
- 11 Fixed photoelectric cell
- 12 Film pulling by servo rollers
- 13 Scissors group of easy dismantling system for maintenance
- 14 Transfer gripper to carousel
- 15 Opening Station
- 16 Filling station (3)
- 17 Independent stretching unit from sachet top side
- 18 Top Sealing by means of Ultrasonic

- 1 Axe de bobine expansible de fixation pneumatique
- 2 Deuxième axe bobine
- 3 Embranchement bobine automatique
- 4 1er group de rouleaux d'entrée compensés
- 5 Entraînement debobinateur
- 6 Perforateur de fond de réglage facile
- 7 Triangle formateur (changer la pointe du triangle pour formats additionnels)
- 8 Alignement de film
- 9 Groups soudure (4 soudures motorisées)
- 10 Refroidisseur
- 11 Photocellule
- 12 Entraînement par rouleaux servo
- 13 Groupe ciseaux avec système de démontage facile pour nettoyage
- 14 Pince transfert à carrousel
- 15 Station d'ouverture
- 16 Poste de dosage (3)
- 17 Étirage partie supérieure sachet
- 18 Soudure supérieure par Ultrasons

# GPC-60



## TECHNICAL DATA GPC-60

	FLAT	STAND UP	ZIPPER
Filling stations	3	3	3
Maximum volume (1)	1500 cc	2000 cc	1800 cc
Outside reel diameter	800 mm	800 mm	800 mm
Core reel diameter	70-75 mm / 150-155 mm		
Maximum output	180-200 spm	180 spm	180-200 spm
Power consumption	20 kw	27 kw	30 kw
Air consumption (2)	250 l/min.	300 l/min.	350 l/min.

(1) Depending on product, film, formats and final machine configuration.

(2) Approx. data are for guidance only.

Effytec reserve the right to modify the machines due to ongoing technical development without prior notice.



### EFICIENCIA Y TECNOLOGÍA, S.A.





c/ Bellveí 41-49, nave 9 - Pol. Industrial Can Salvatella

08210 Barberà del Vallès - Barcelona (Spain)

Telf. (+34) 93 718 58 40 - Fax: (+34) 93 718 82 21

www.effytec.com - info@effytec.com

## TYPES OF SACHETS

	FLAT	STAND UP	ZIPPER
 STAND UP		●	●
 DELTA		●	●
 ZIPPER FLAT SACHET			●
 FLAT SACHET 3/4 SEALING	●	●	●
 GUSSET	●	●	●
 EUROHOLE	●	●	●
 FLAT SACHET PARTIAL SHAPED	●	●	●

## SACHET RANGE DIMENSIONS

